

ALPHABET

TRACING & COLORING ACTIVITY SHEETS

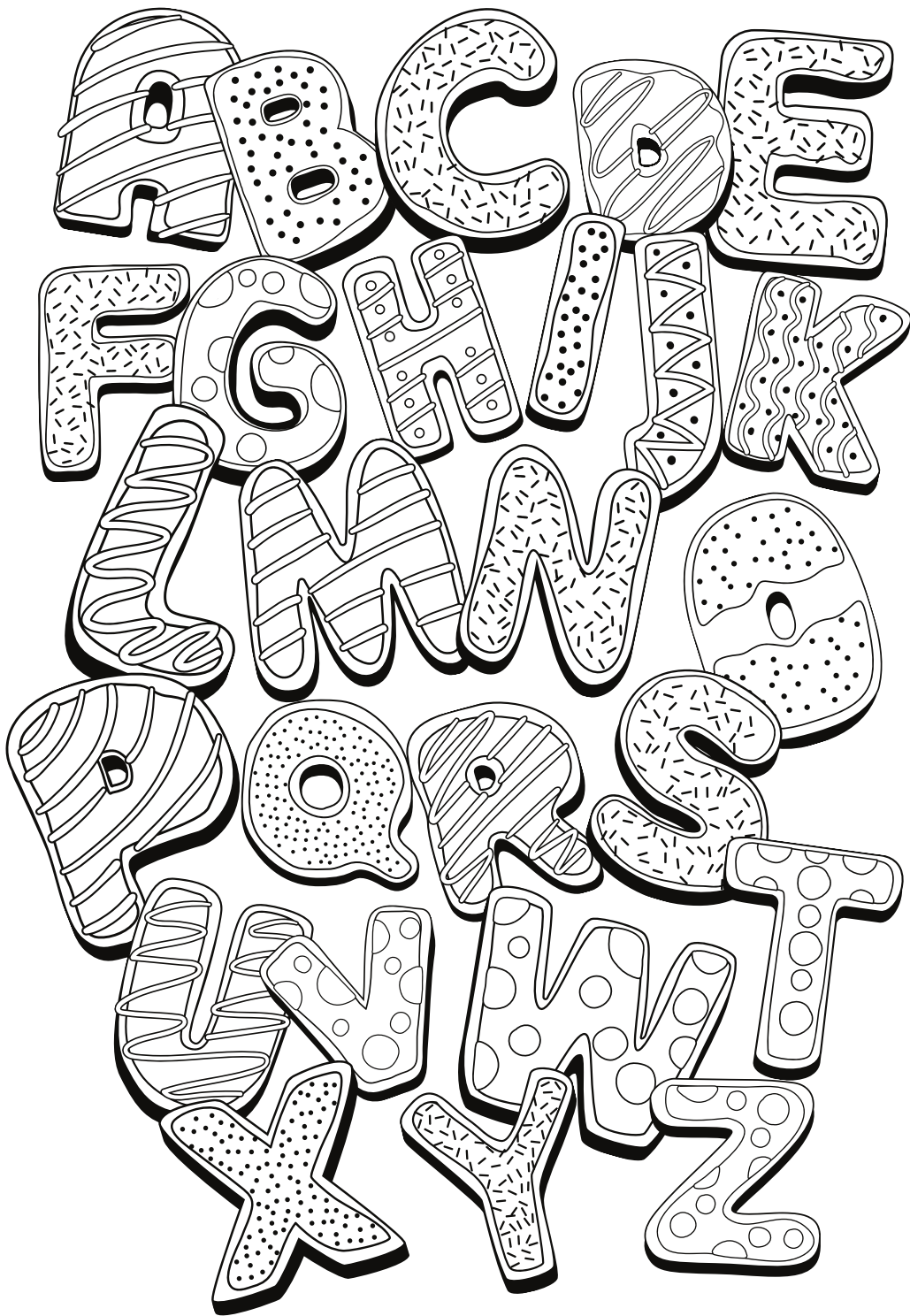

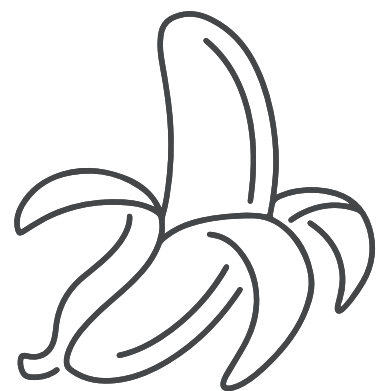
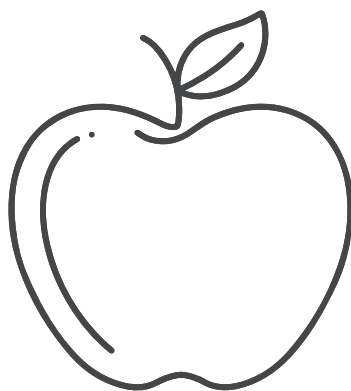
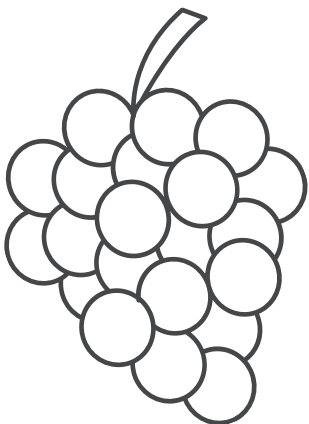
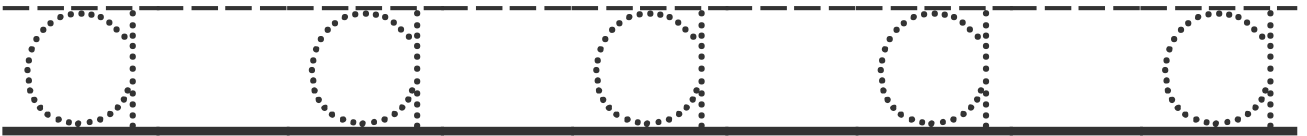
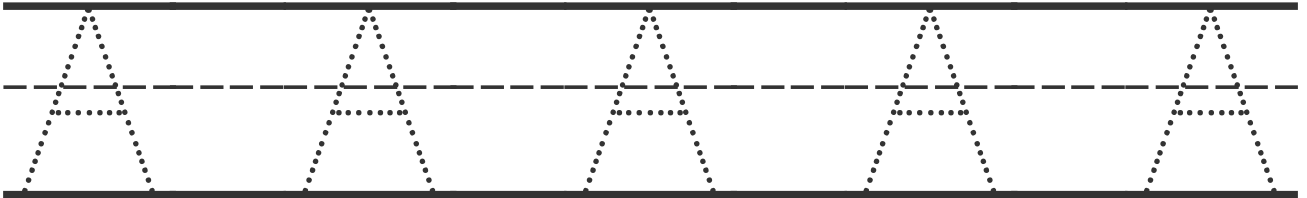
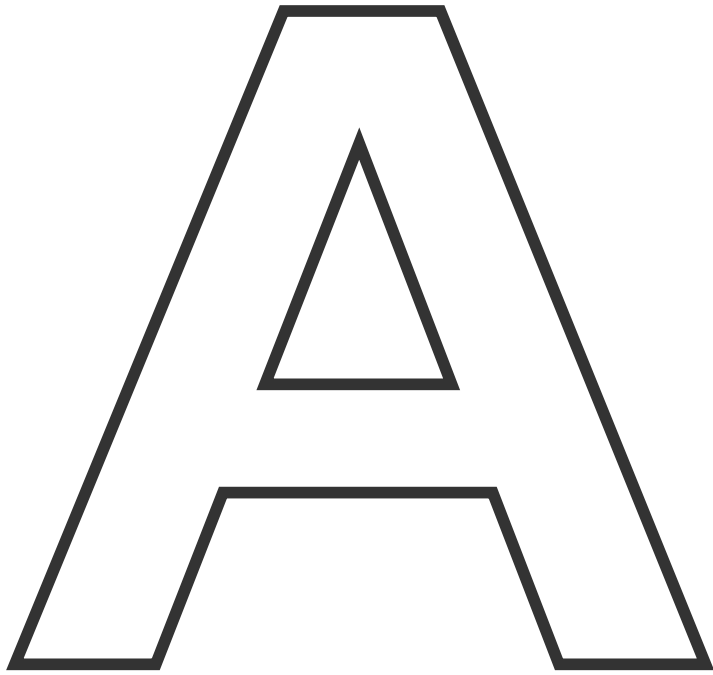

Bb

B B B B B

b b b b b



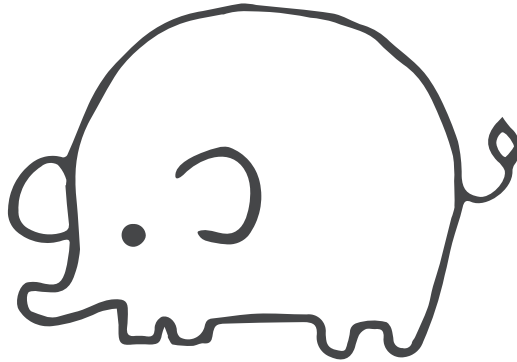
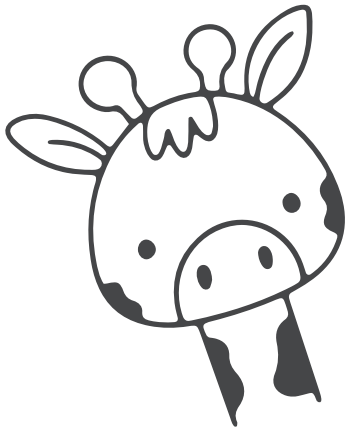
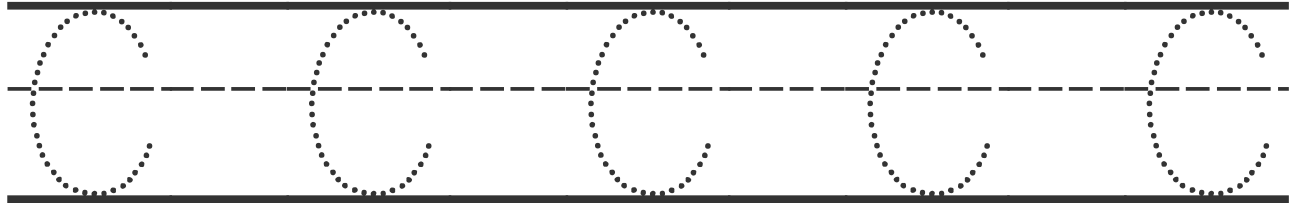
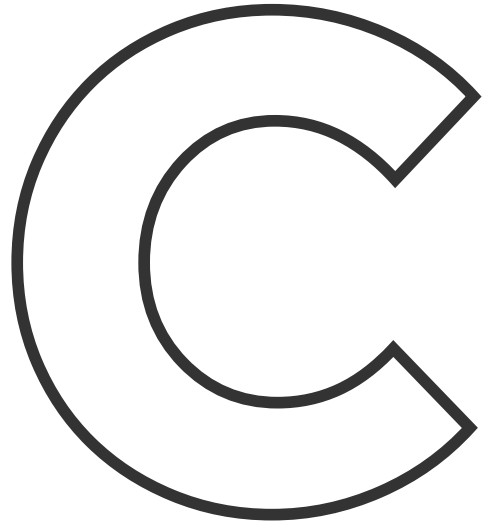
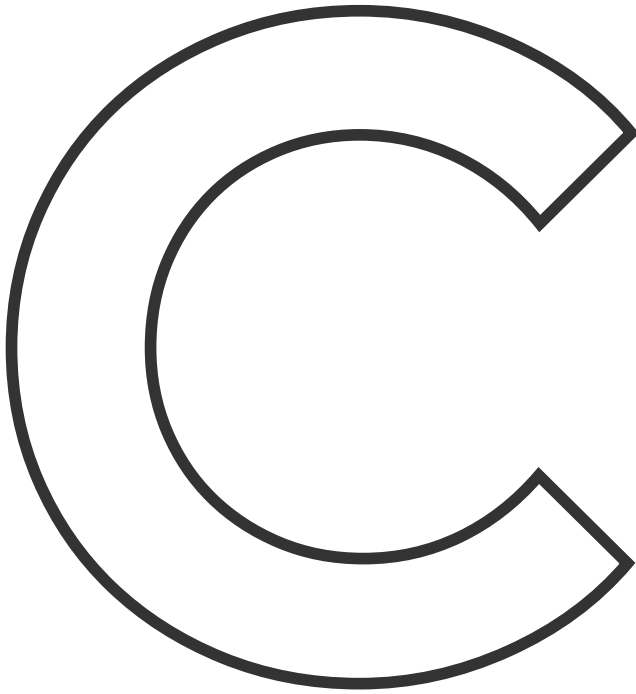

Dd

D D D D D

d d d d d

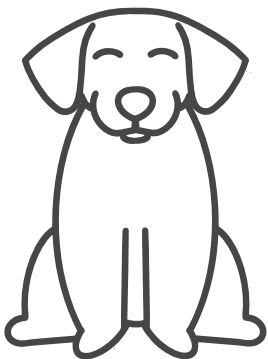

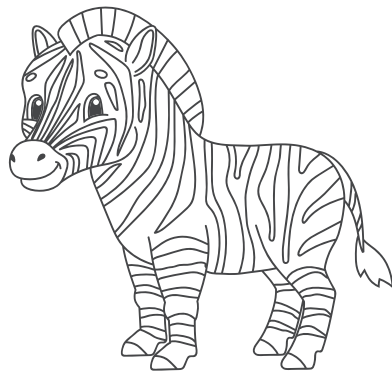
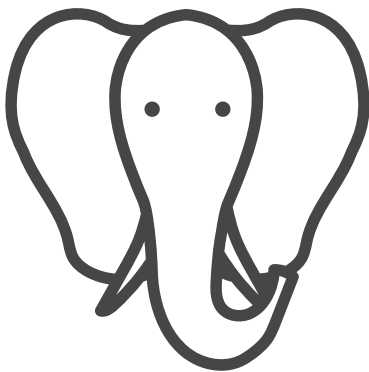
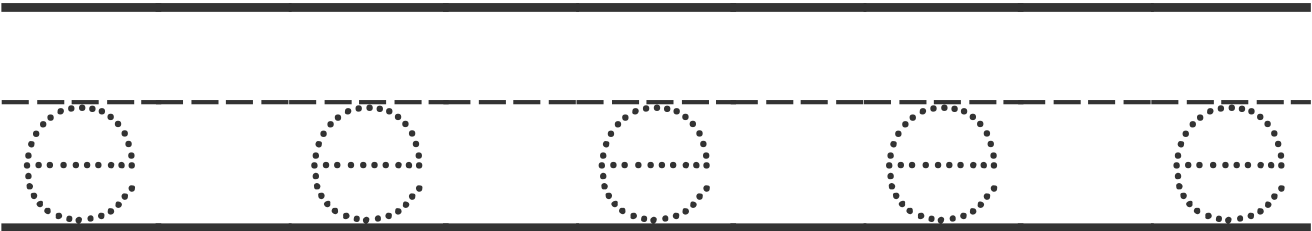
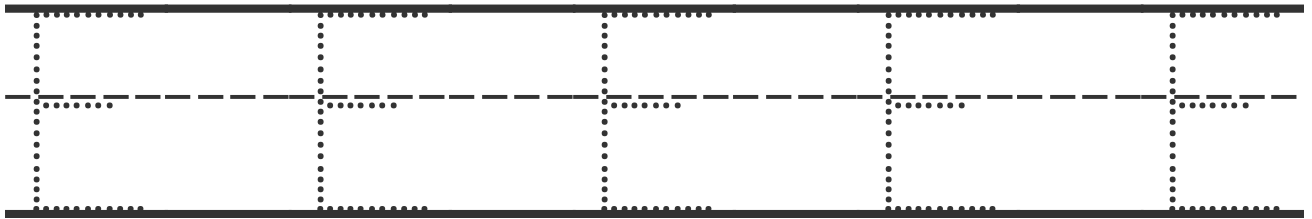
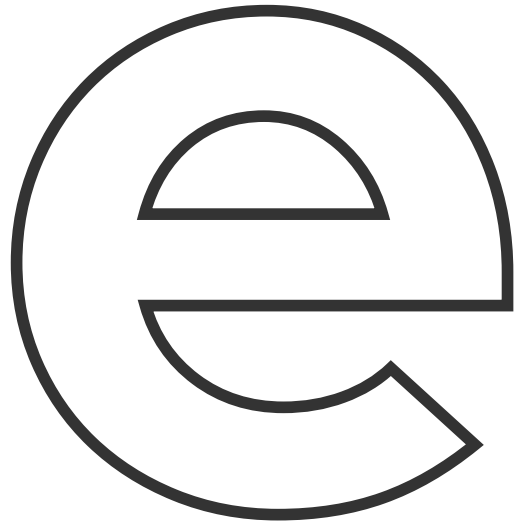
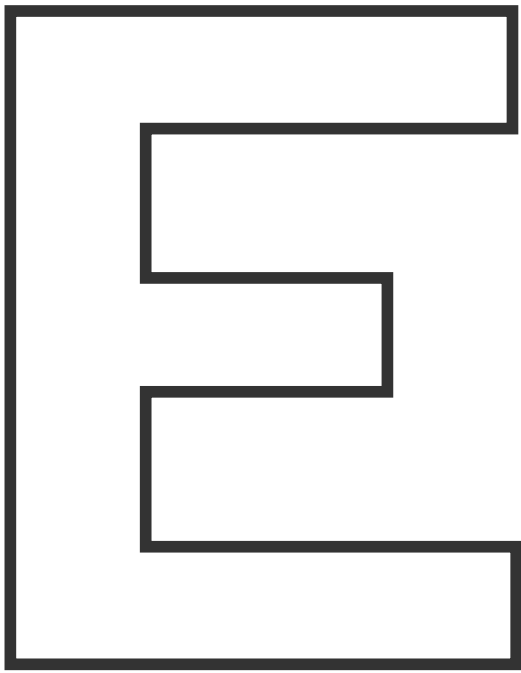

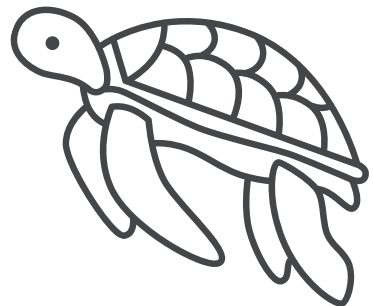
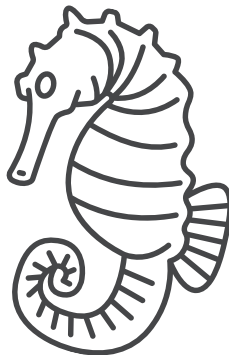
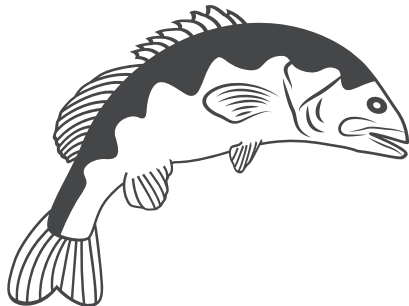
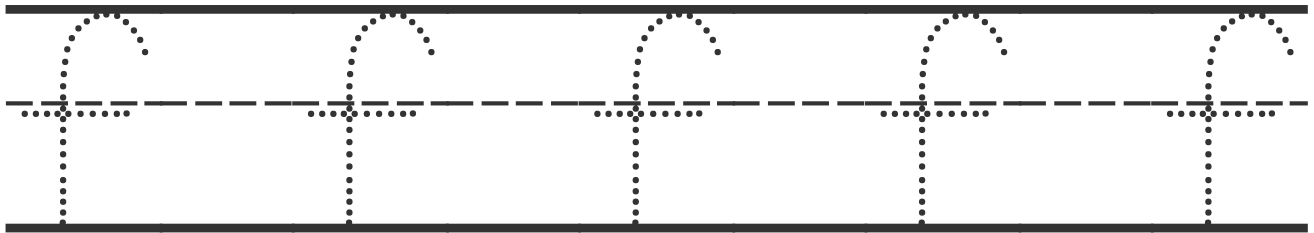
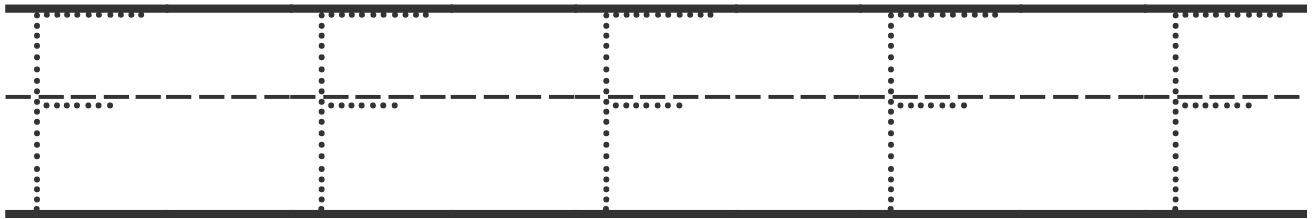
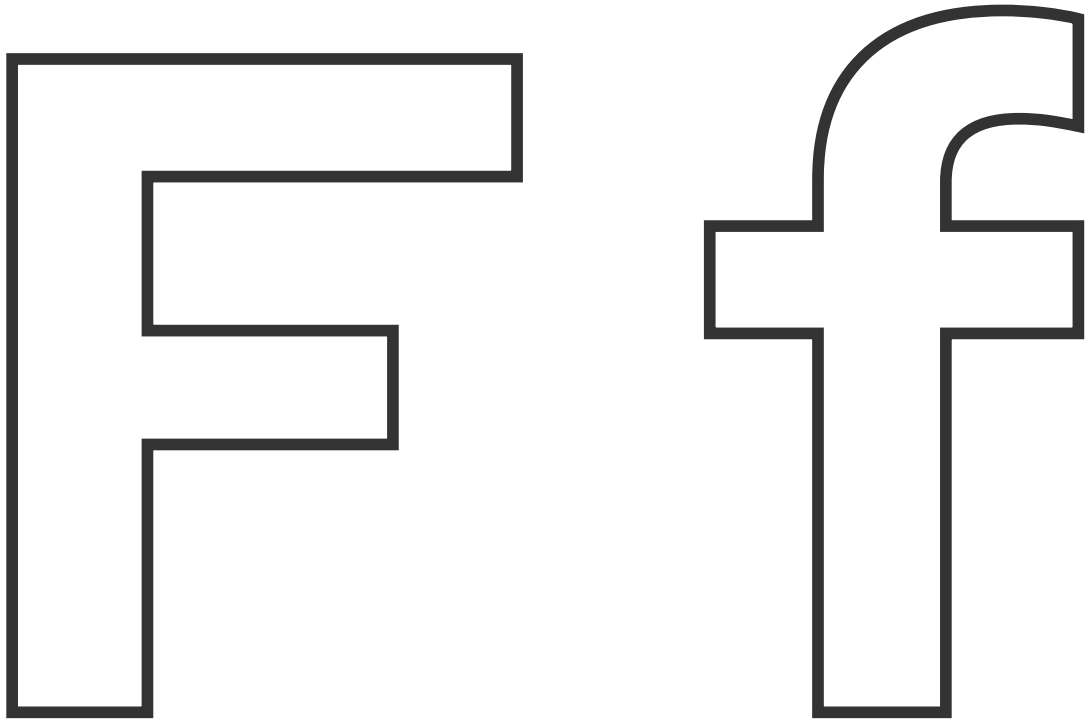

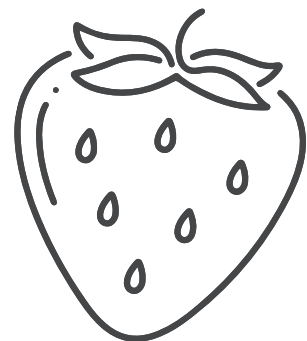
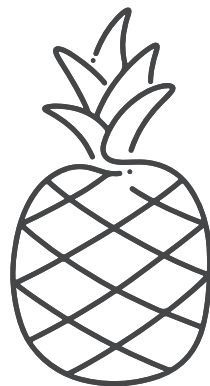
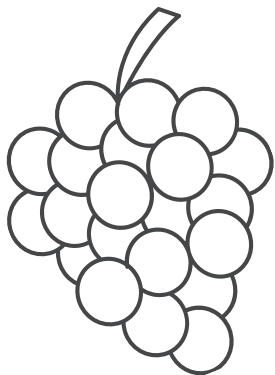
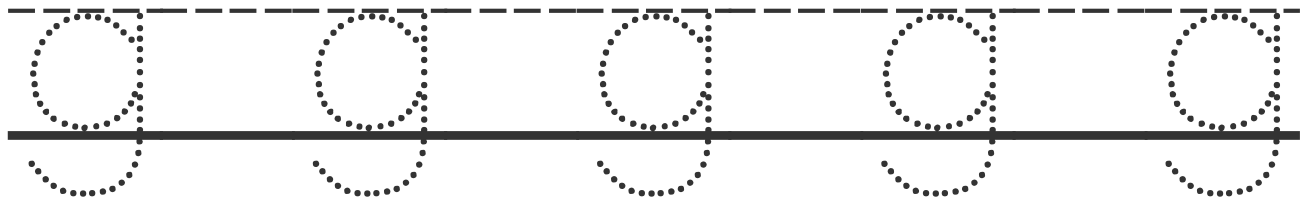
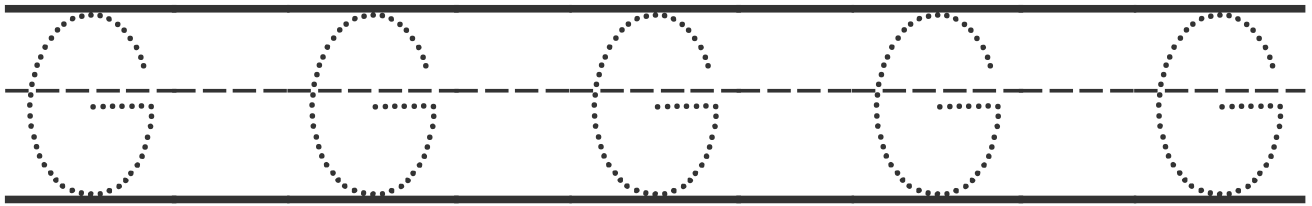

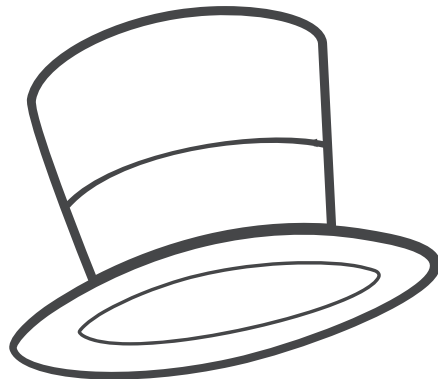
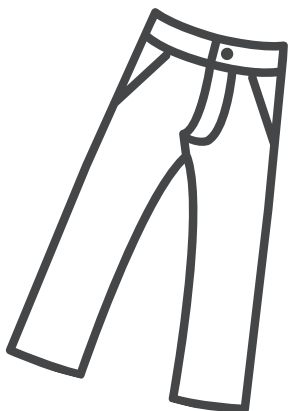
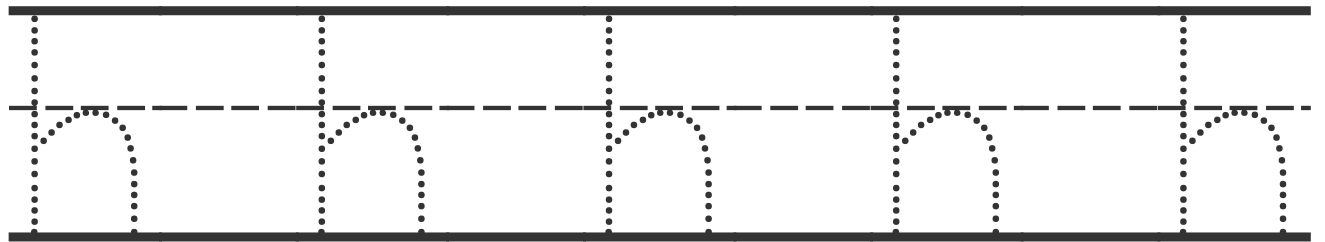
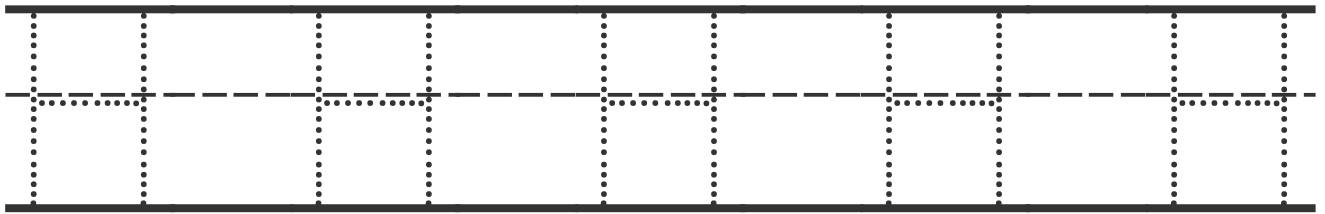

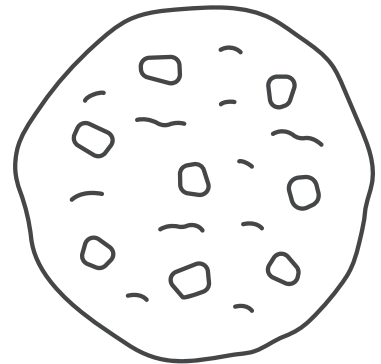
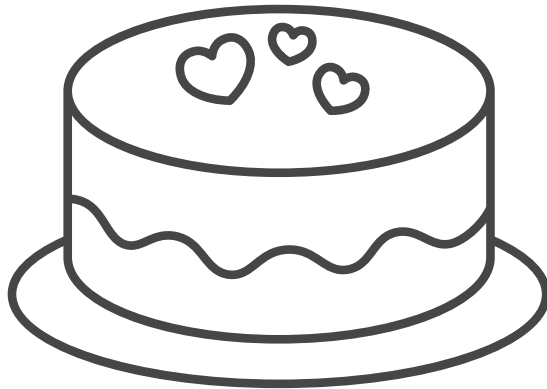
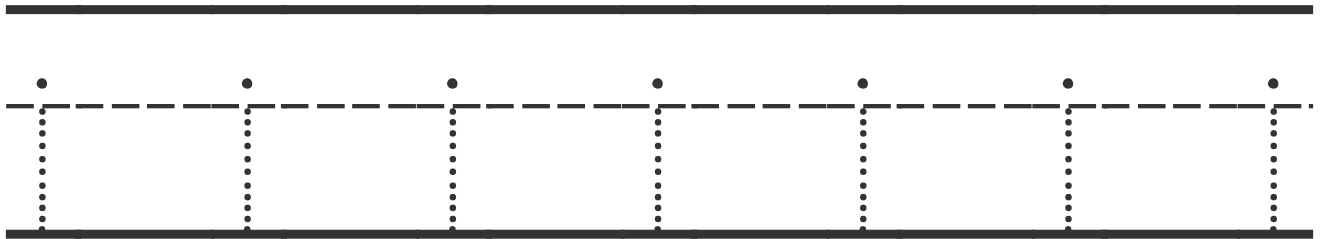
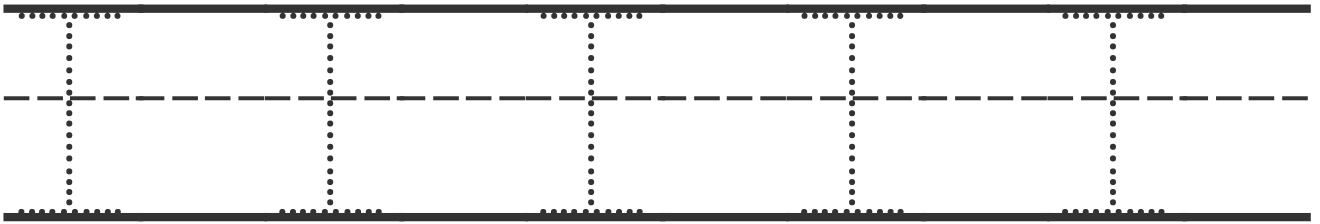
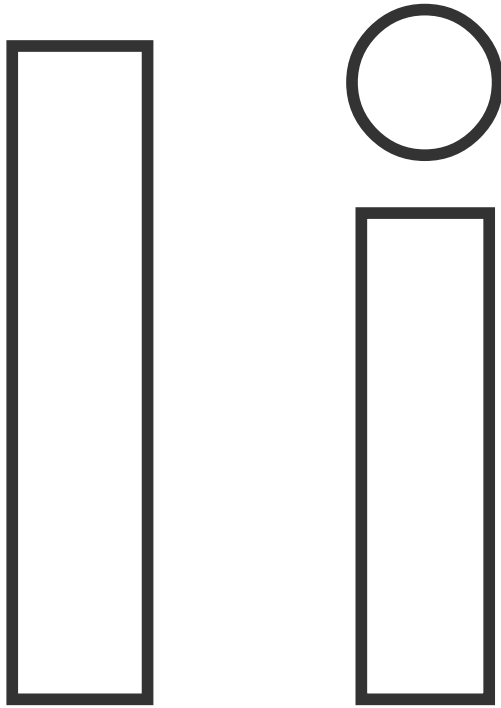

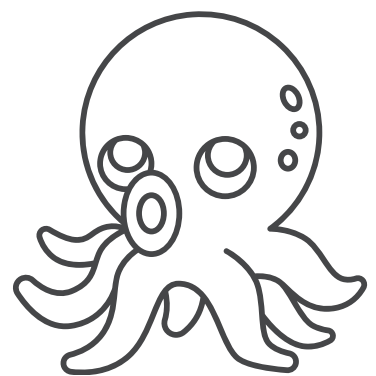
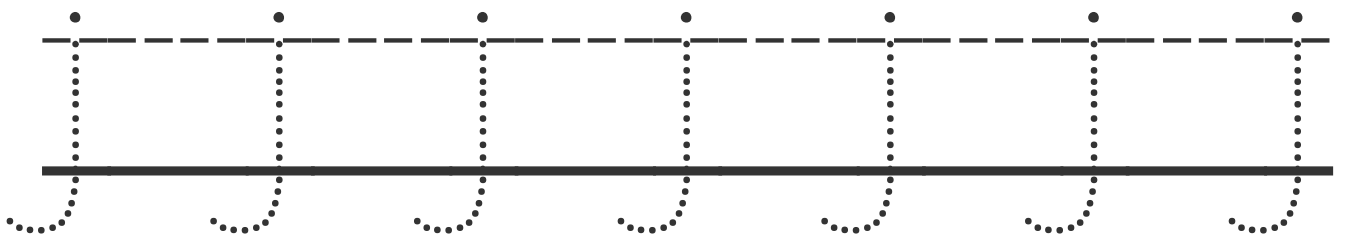
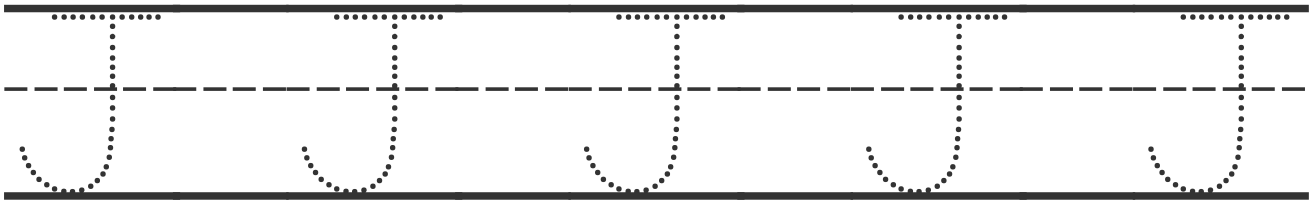
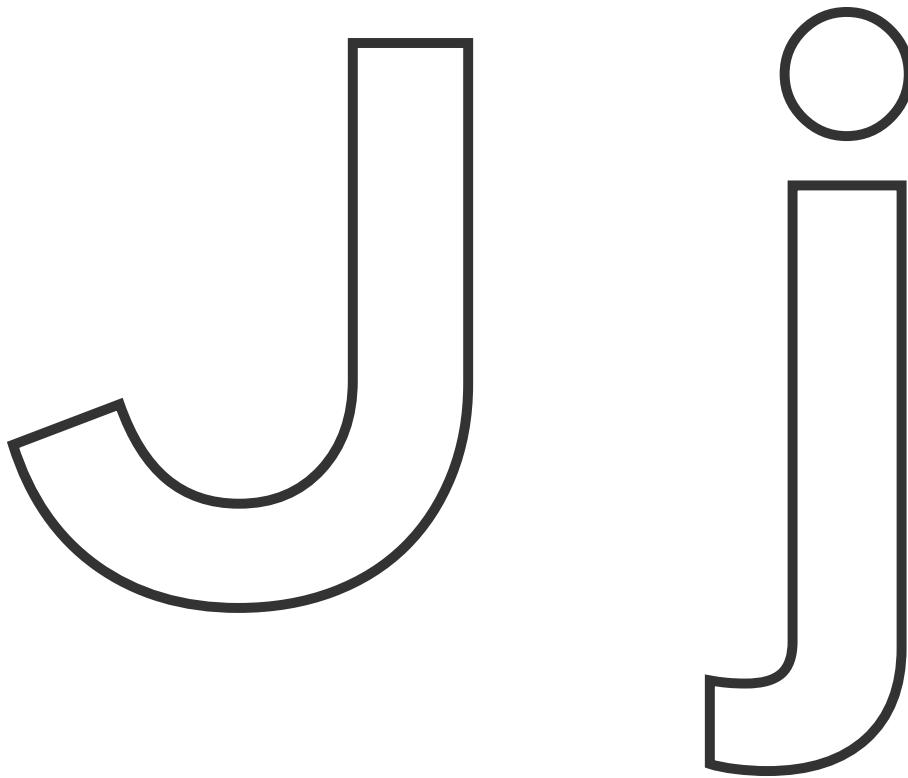

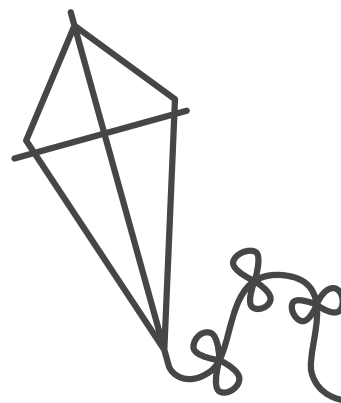
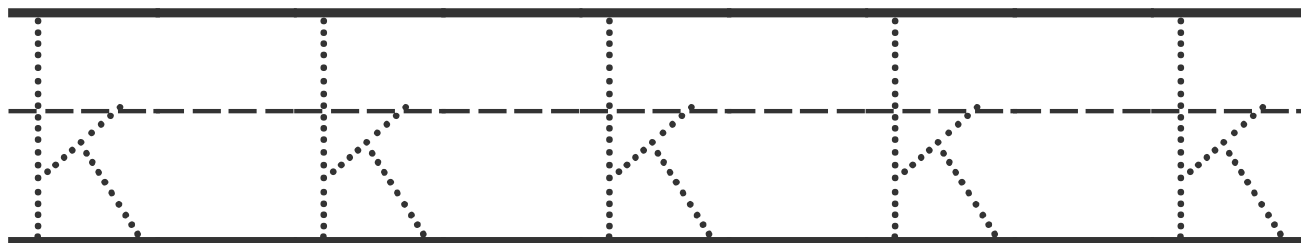
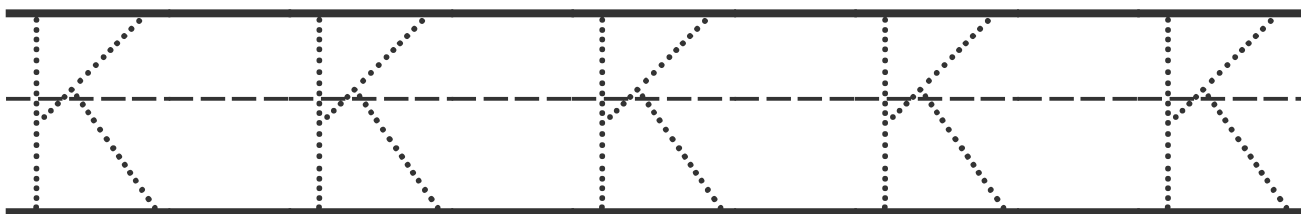

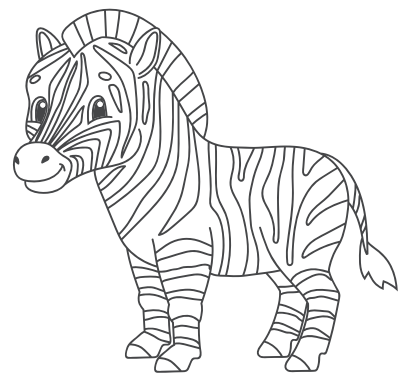
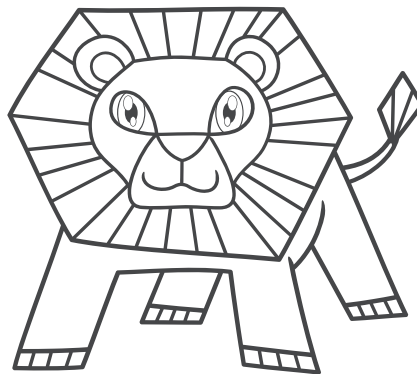
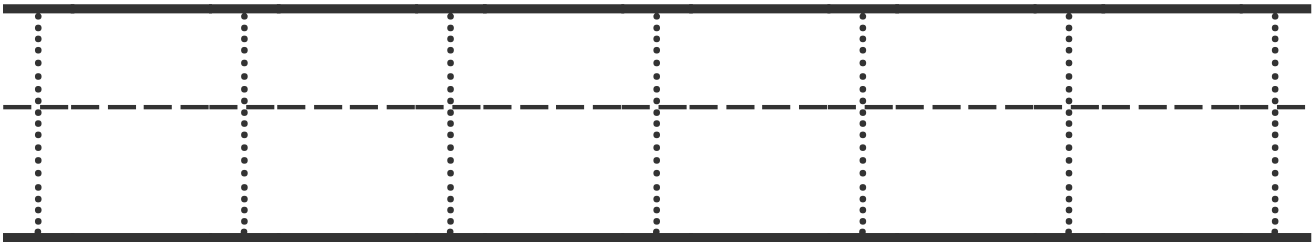
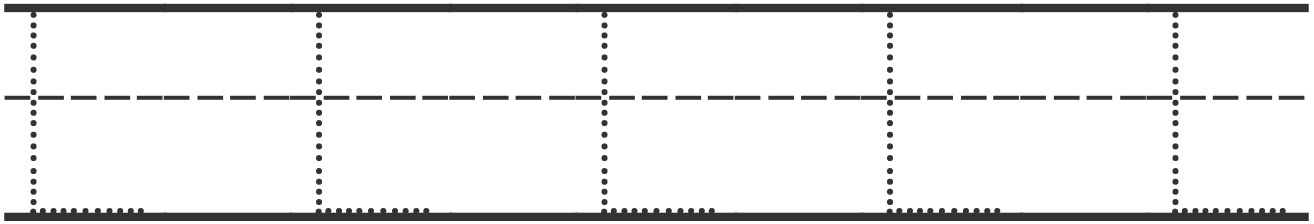
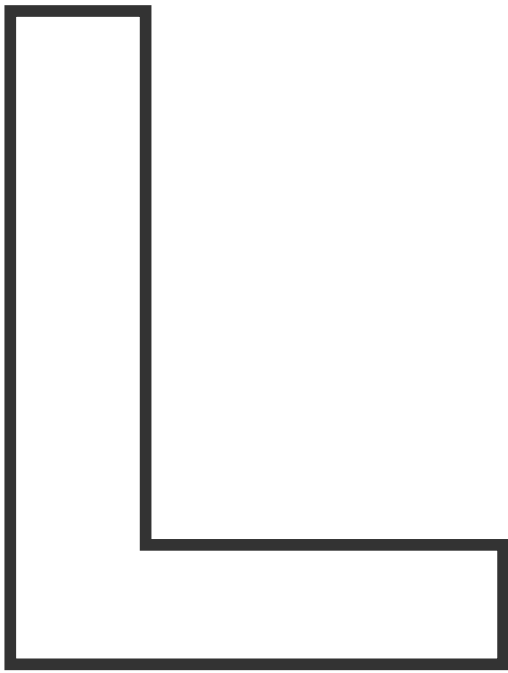

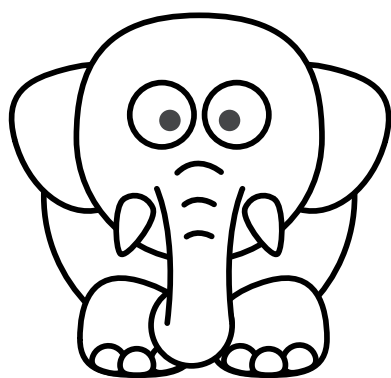
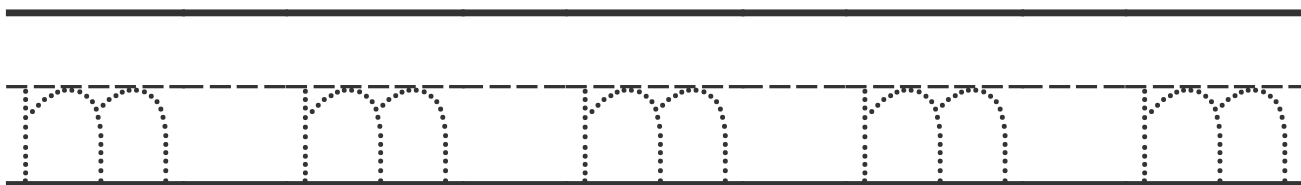
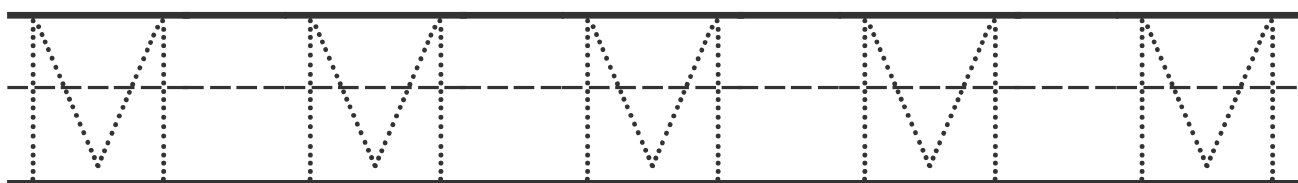

N n

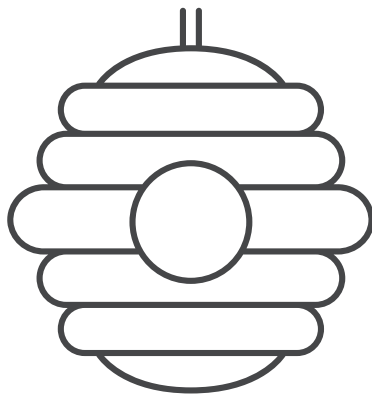
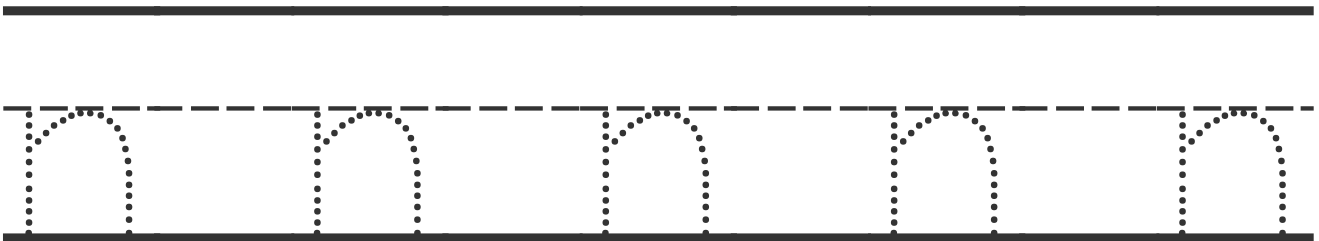
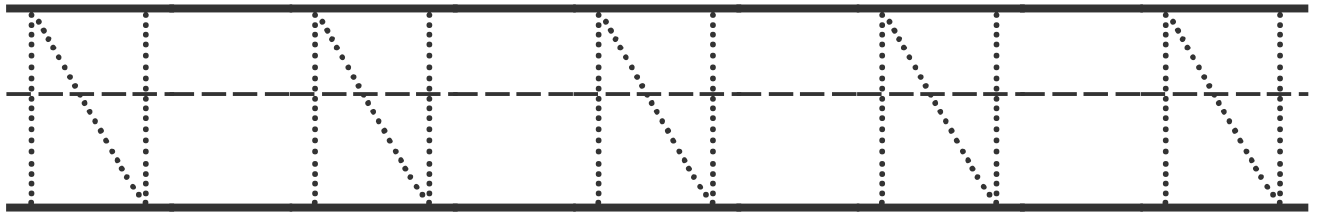

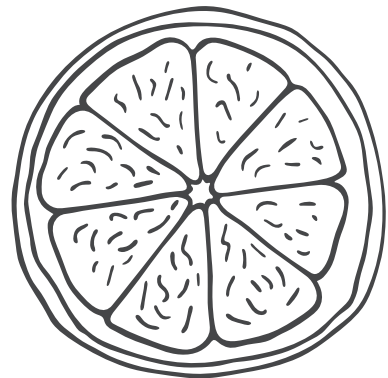
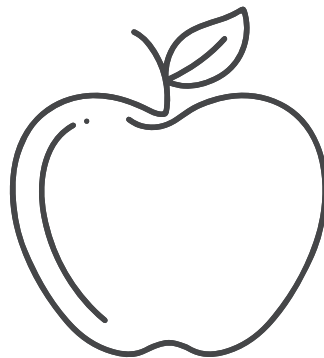
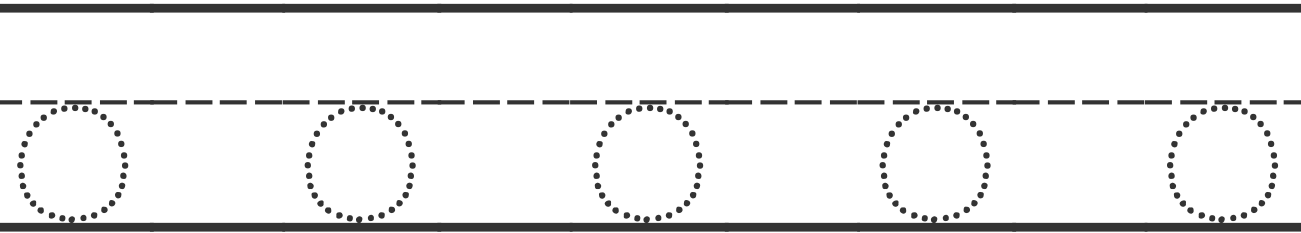
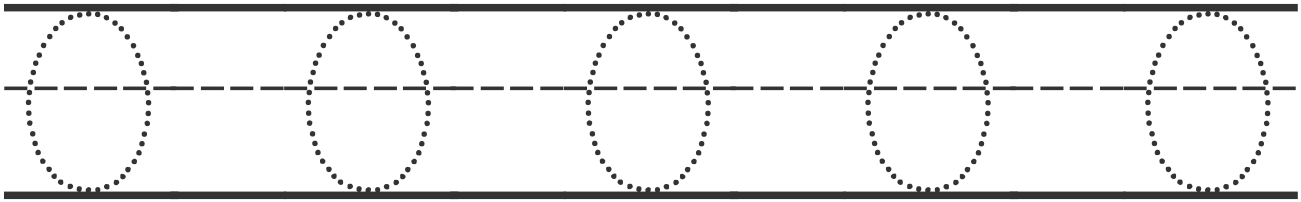
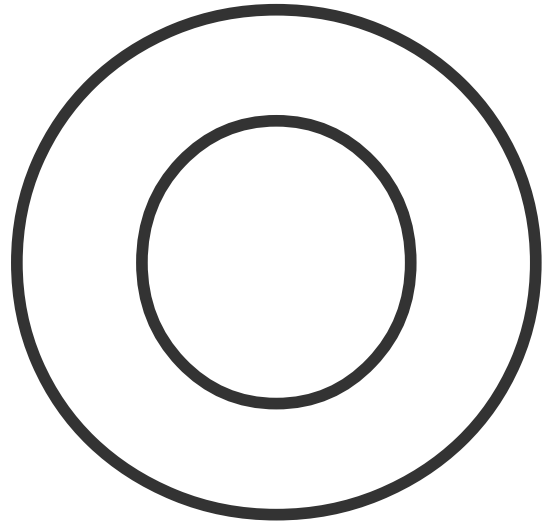
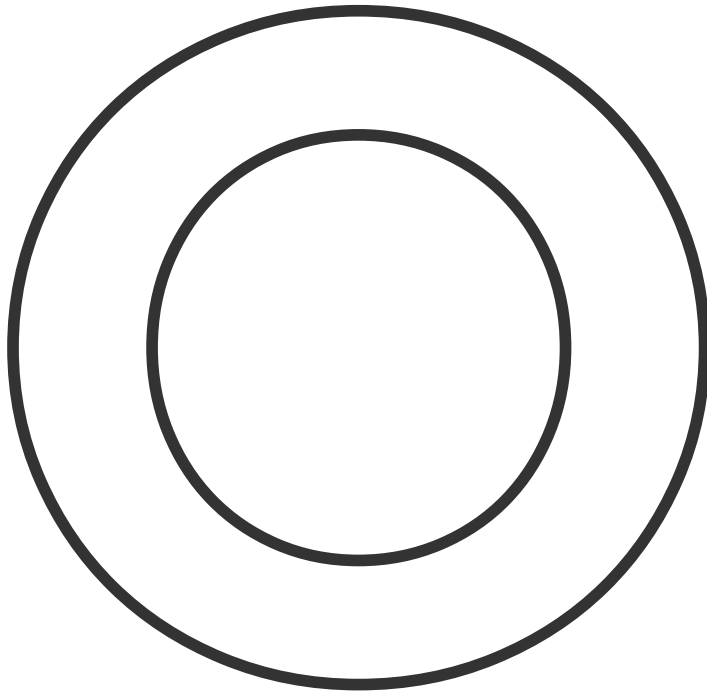

Pp

P P P P P

p p p p p

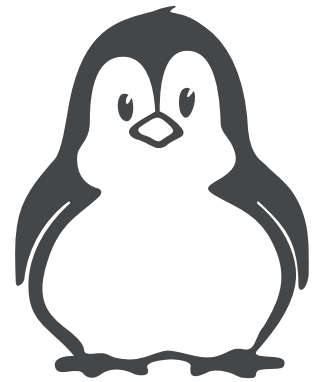
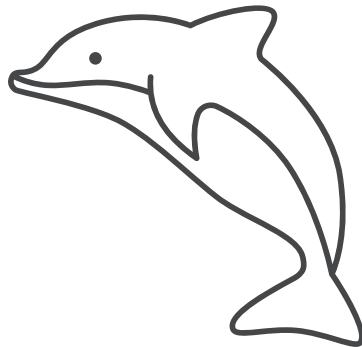

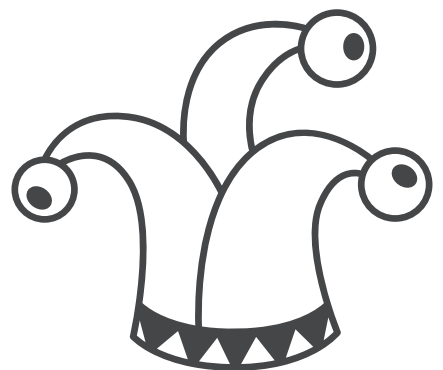
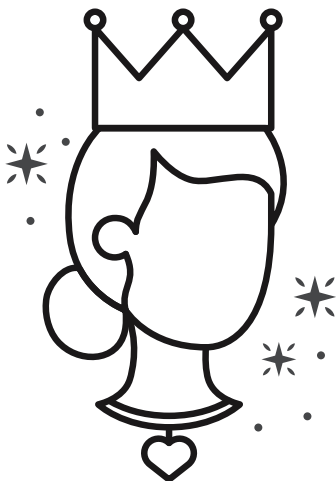
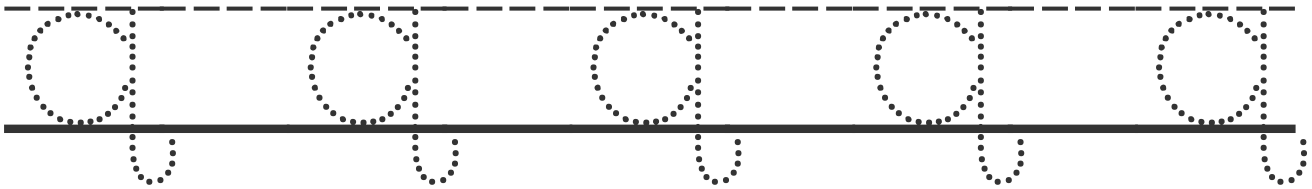
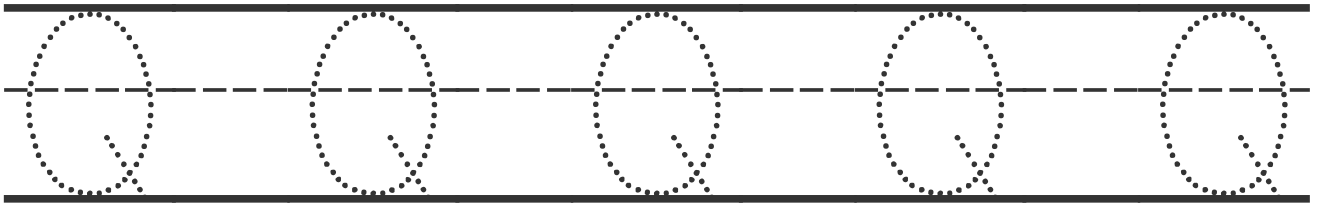
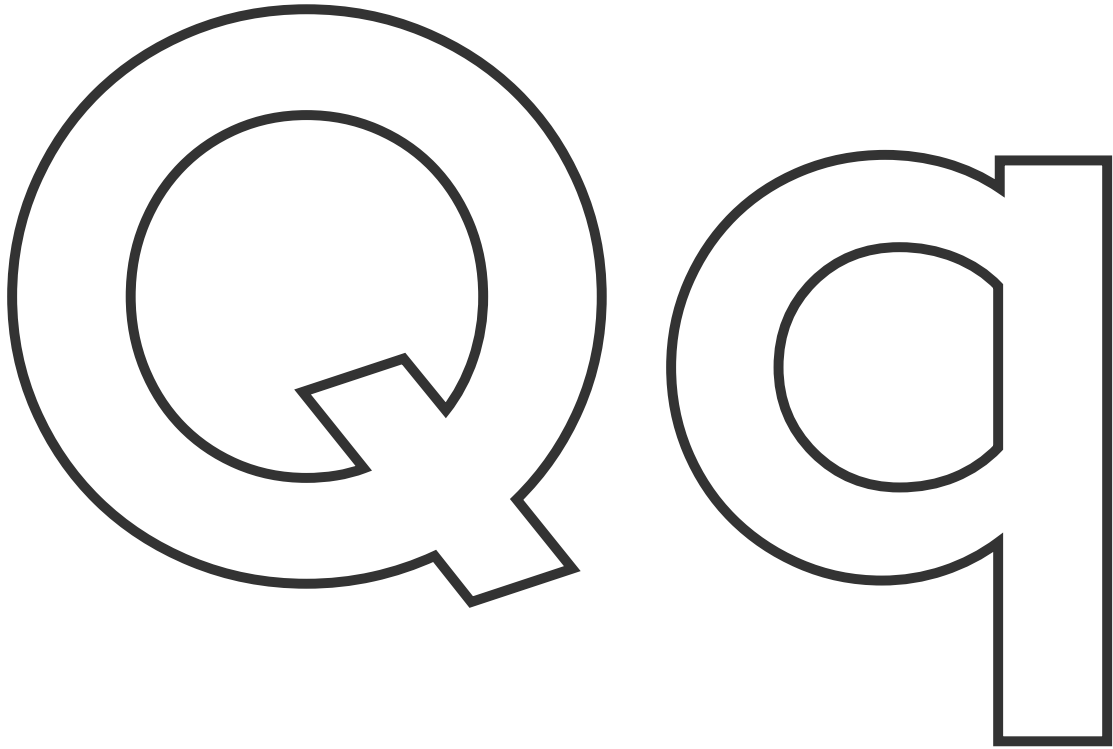

Rr

R R R R R

r r r r r

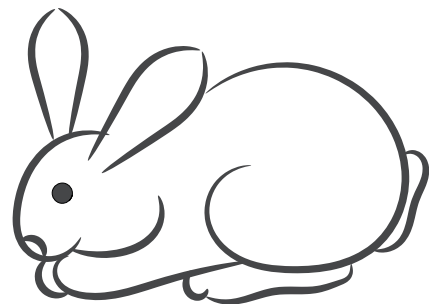
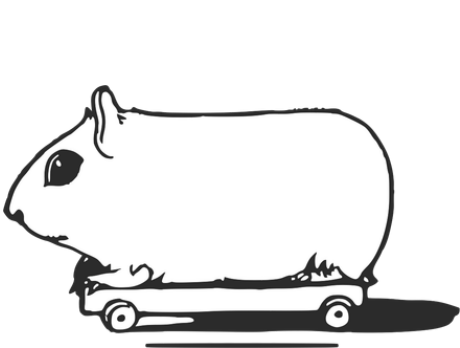

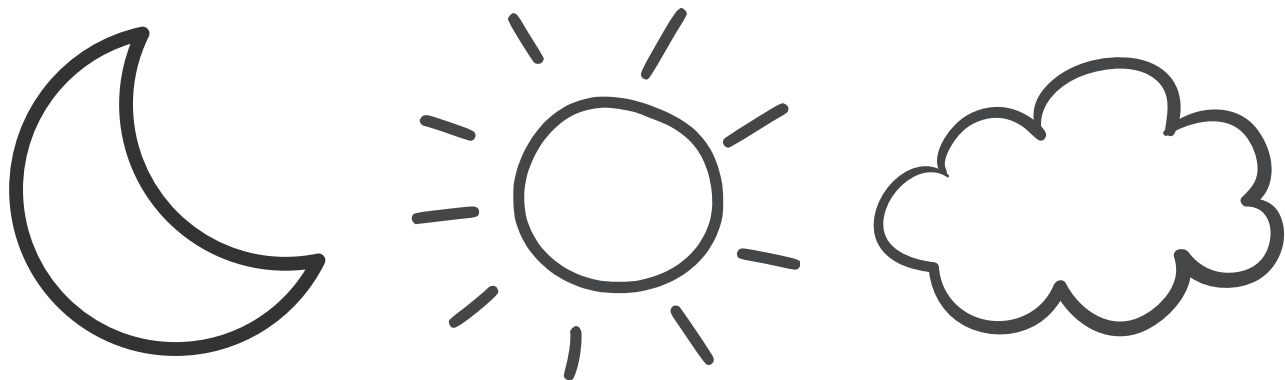
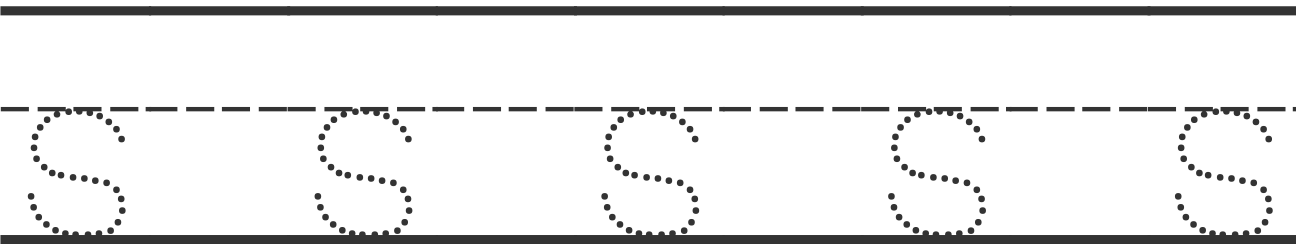
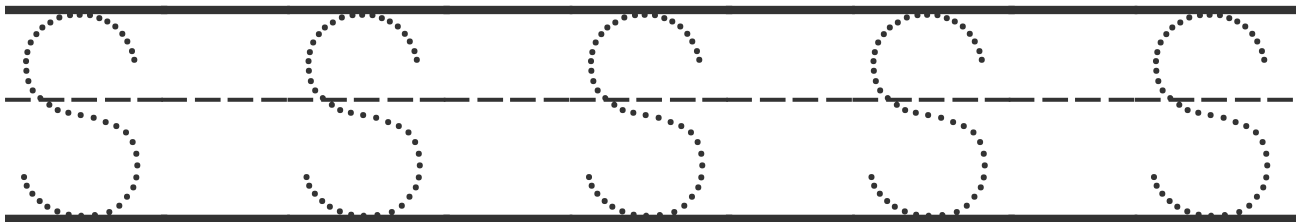

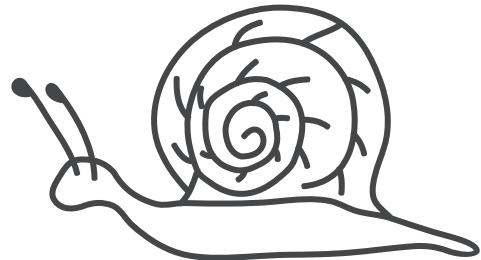
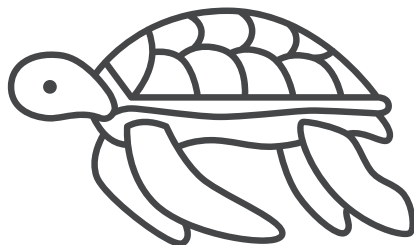
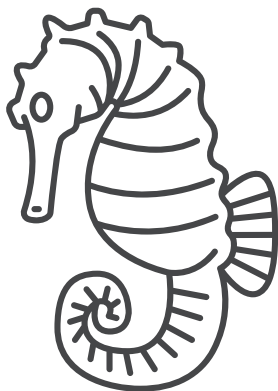
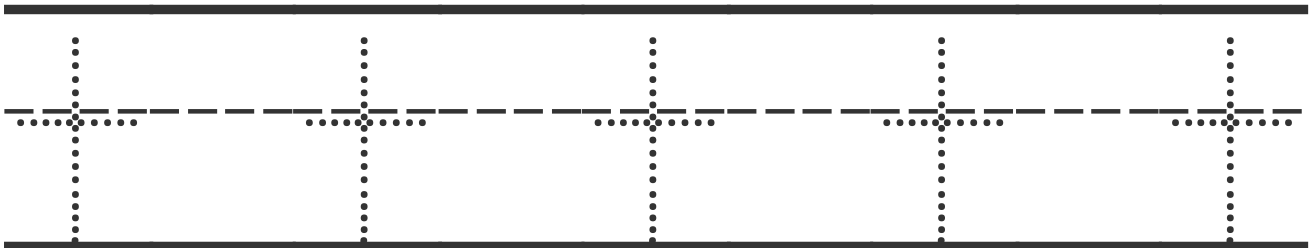
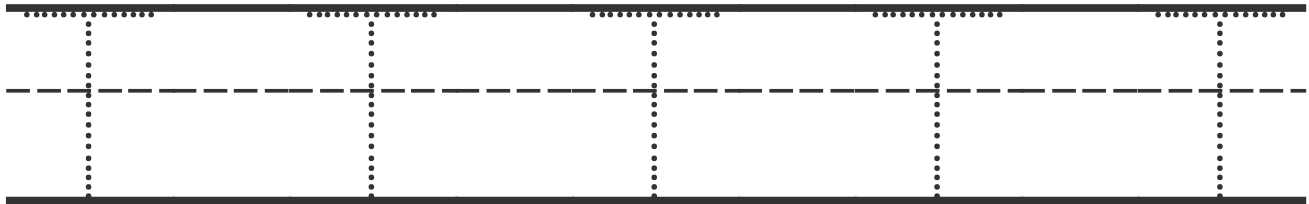
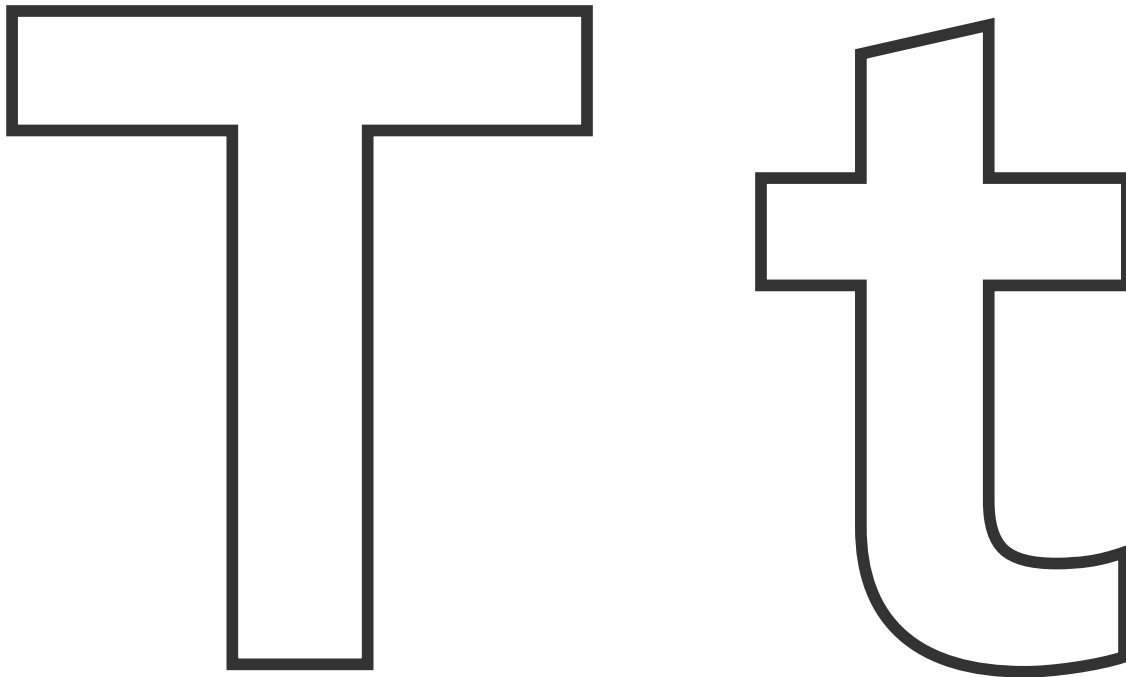

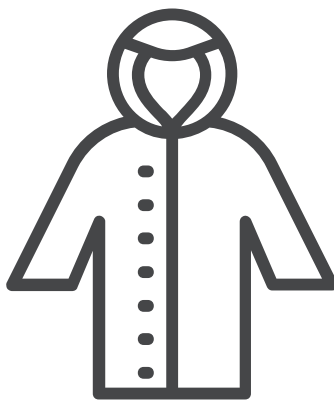
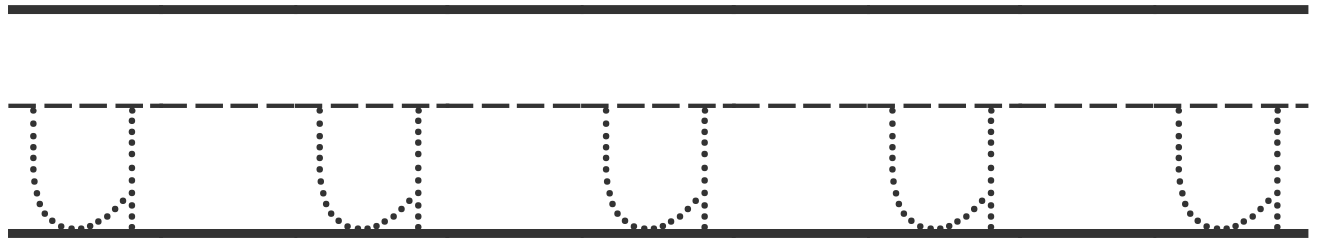
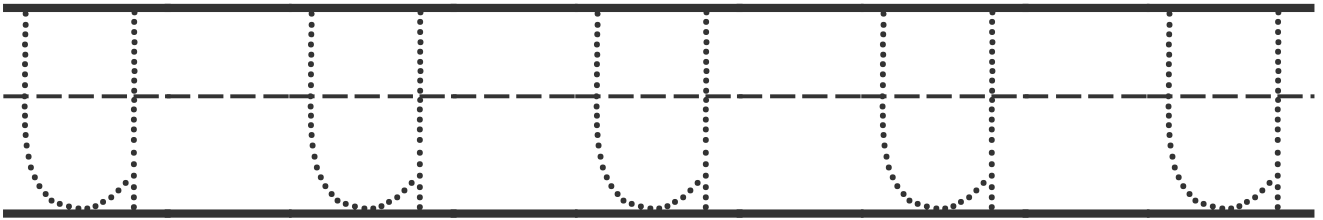
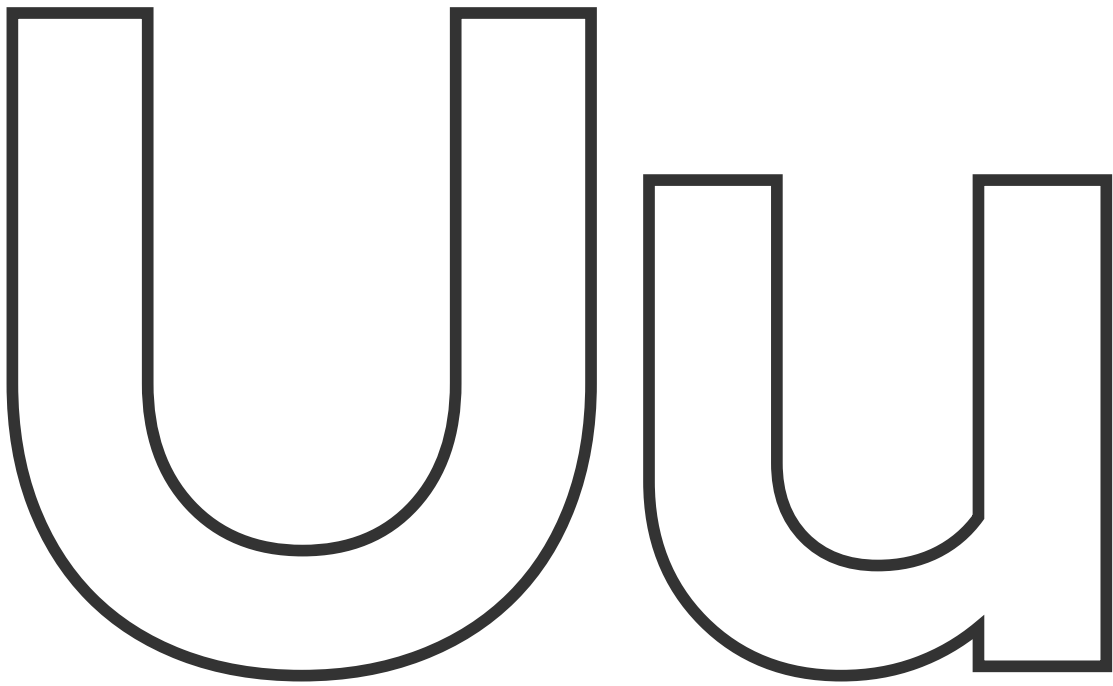

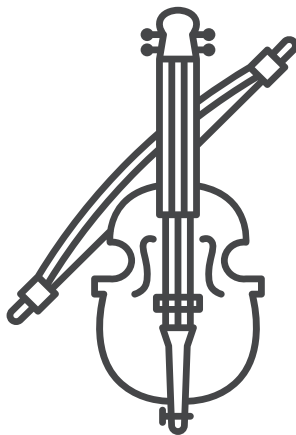
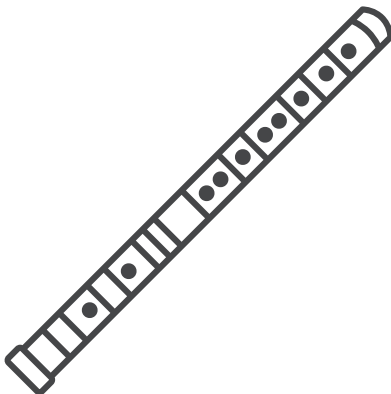
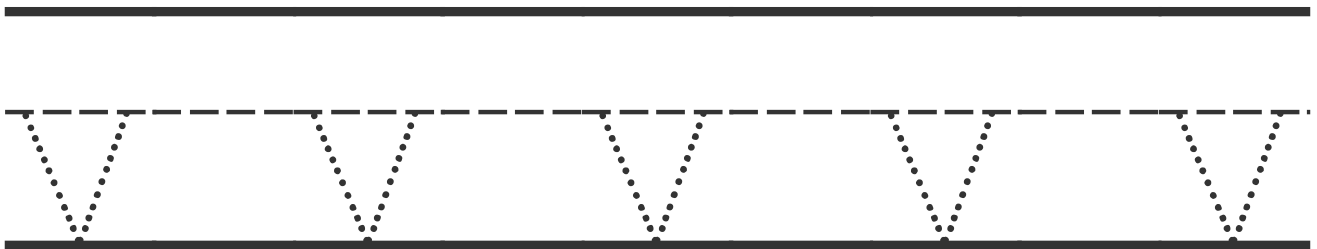
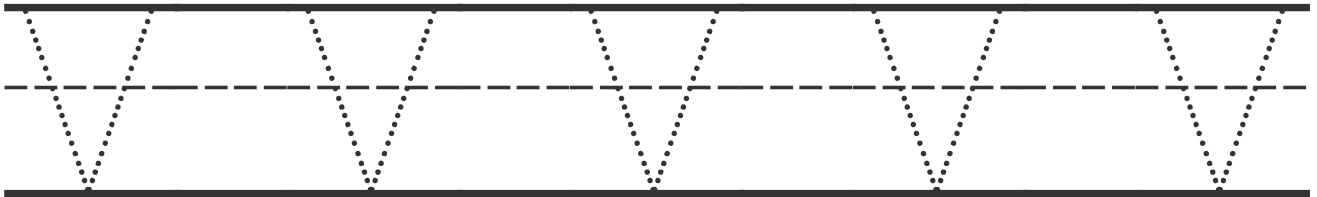

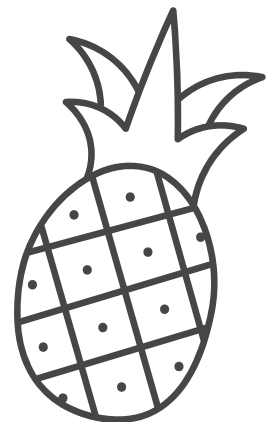
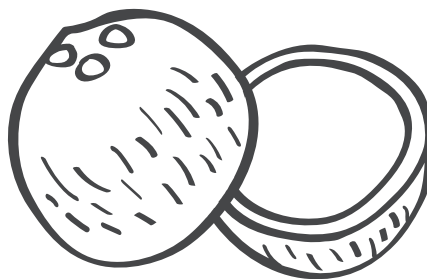
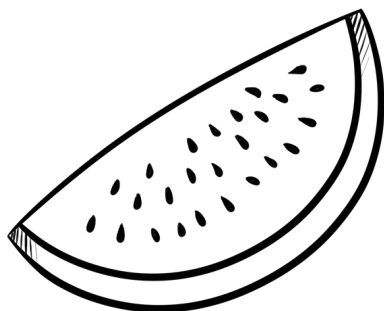
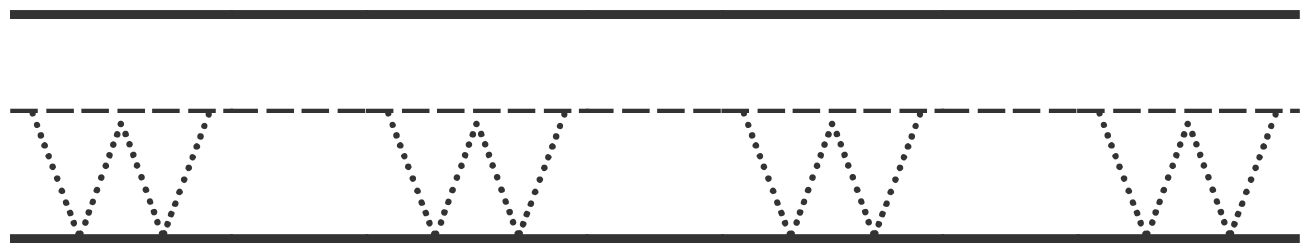
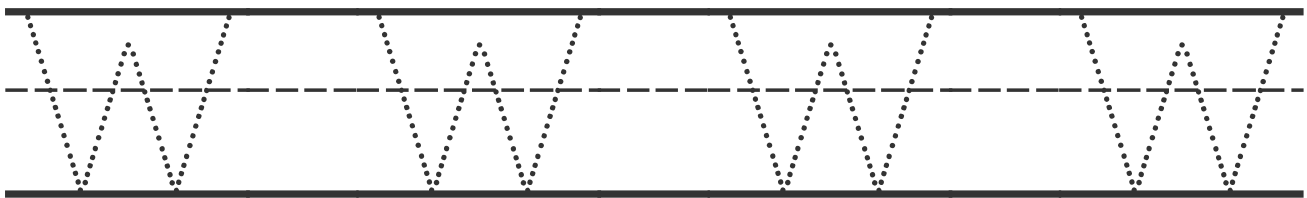

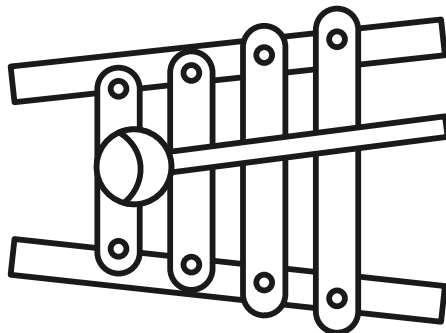
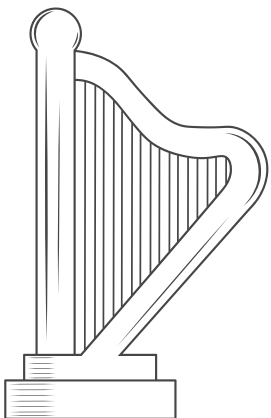
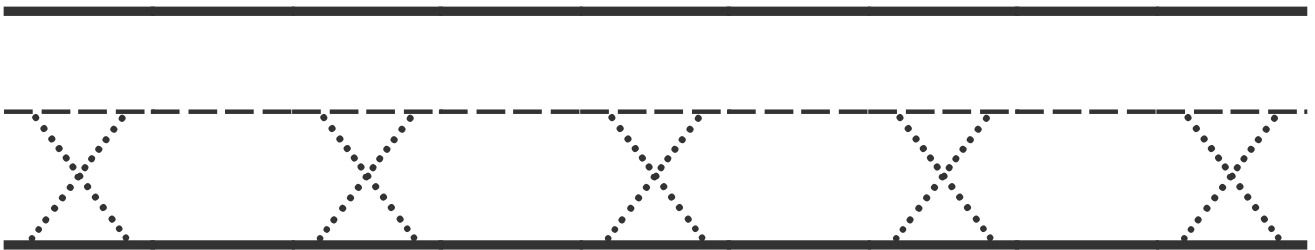
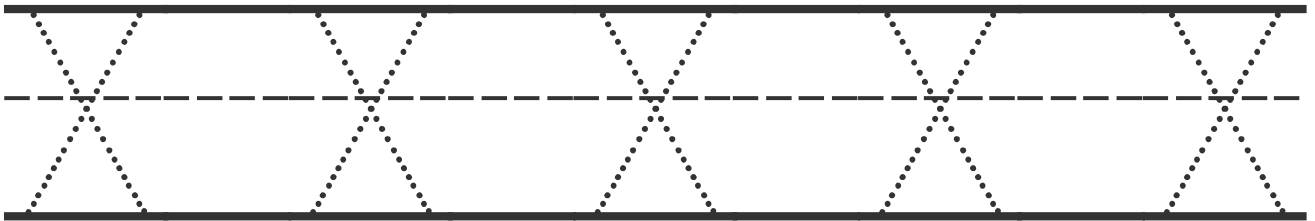
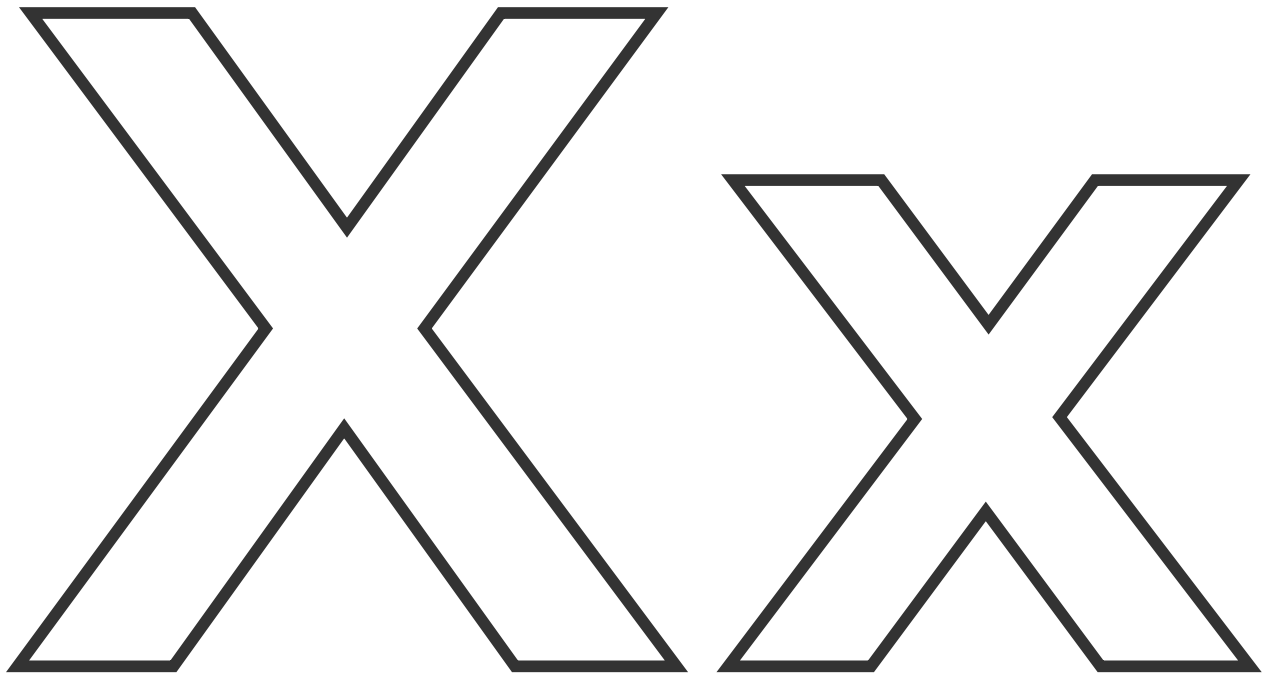

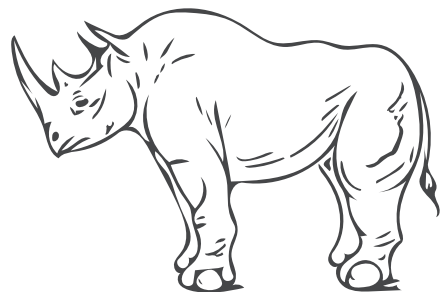
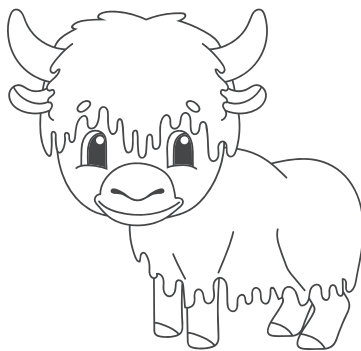
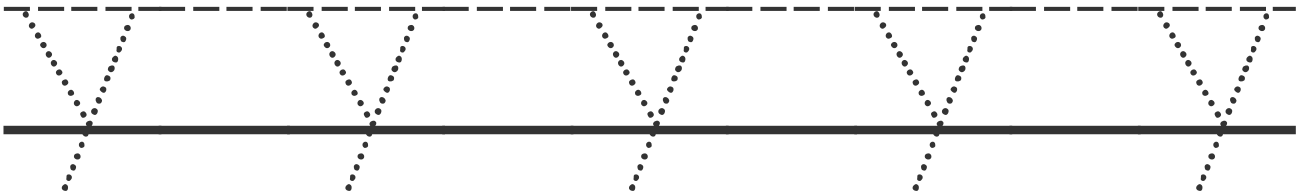
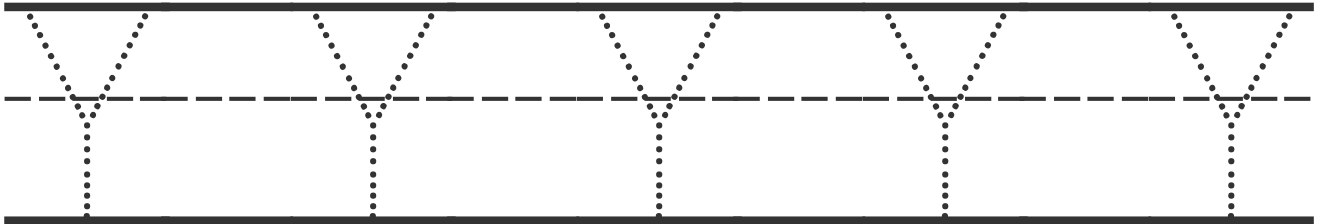
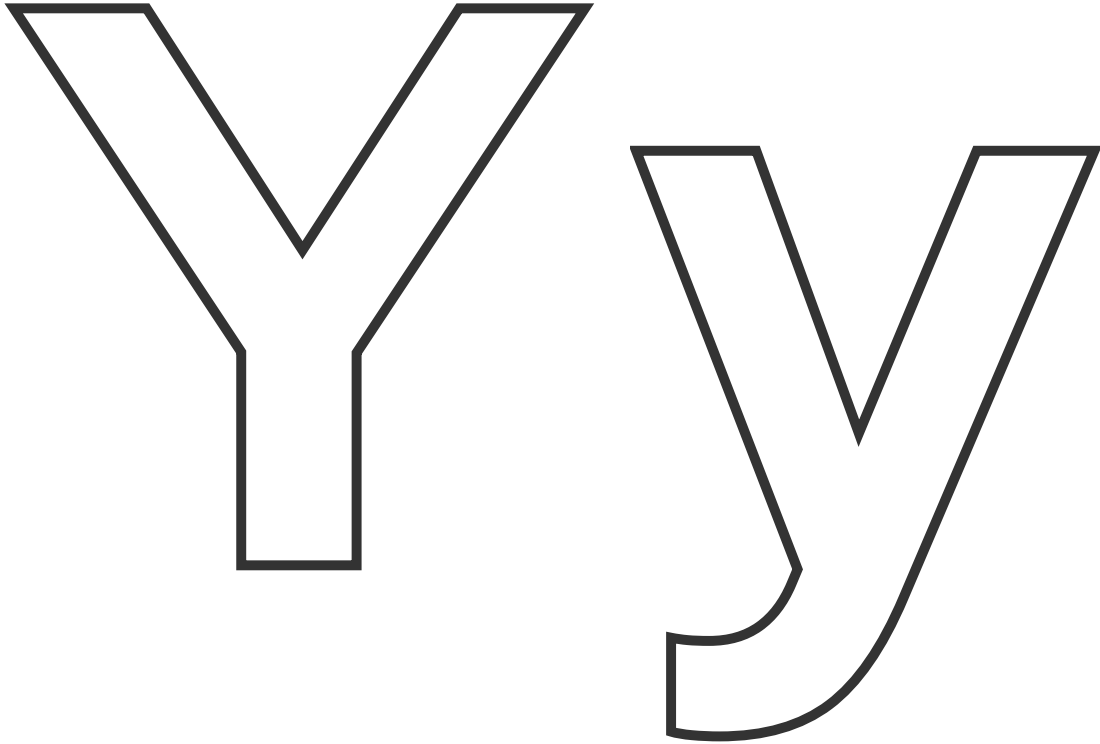

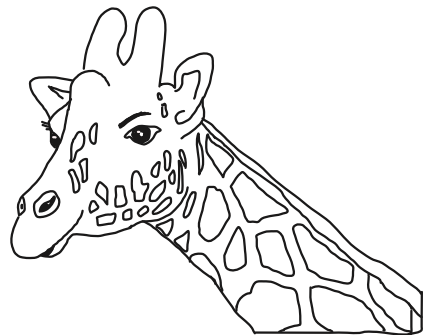
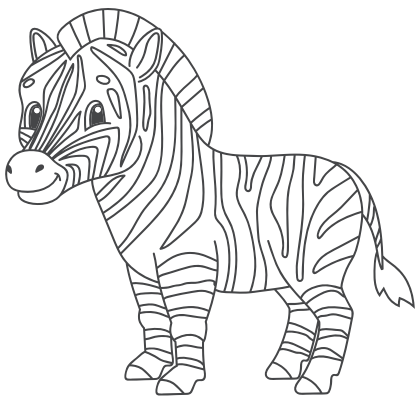
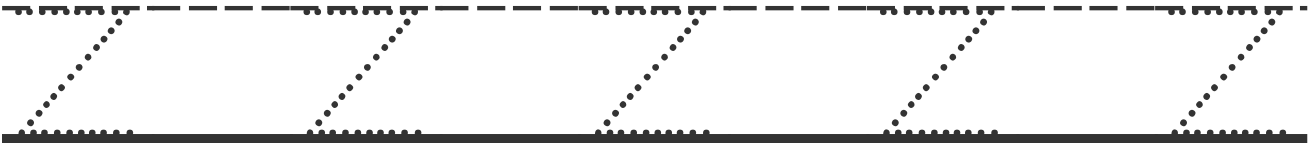
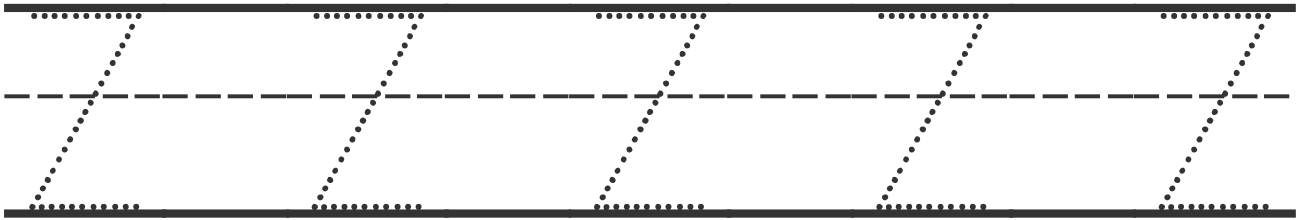
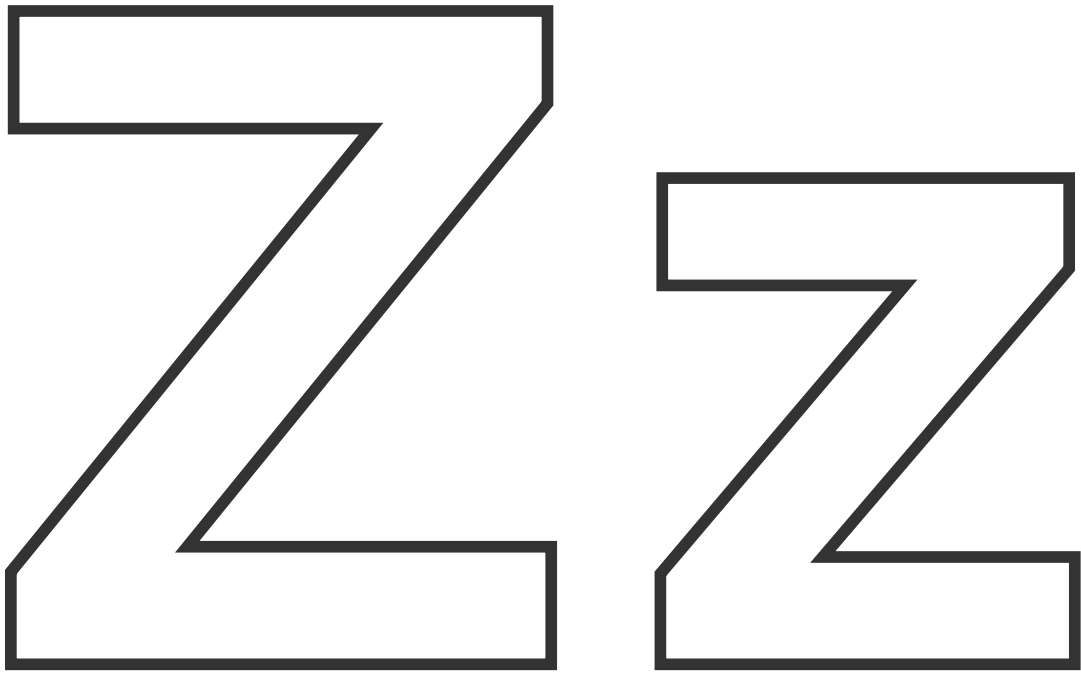



REGION A PARTNERSHIP FOR CHILDREN

PARENTS AS TEACHERS

PAT Educators use the National PAT home visiting model to increase family well-being, support enhanced developmental parenting and parent child interaction while encouraging early literacy, responding to parents' concerns about child rearing and linking families to community resources.

For more information, contact Randi Braun at rbraun@rapc.org or 586-0661.

DOLLY PARTON'S IMAGINATION LIBRARY

Through Smart Start, we are here to help get monthly, high quality, age-appropriate books to children, up until the child's fifth birthday. Families enrolled in Smart Start funded DPIL receive up to 60 books for each child at no cost to families.

Enroll at rapc.org/dpil

SESAME STREET IN COMMUNITIES

In an effort to enhance brain development in a child's early years, Sesame Street in Communities offers bilingual and multimedia support through free tools and resources for children and families, professionals, and community members.

SSIC resources engage children and adults in learning through everyday family routines such as bedtime and healthy meals while also teaching basic early learning concepts as well as addressing concerns such as divorce and homelessness with developmentally appropriate media.

Learn more at ssic.org.

NC PRE-K

We provide access for eligible families to high-quality NC Pre-k services at elementary schools, Head Start centers, and private childcare sites located in Region A's seven westernmost NC counties and on the Qualla Boundary.

NC Pre-K is free for eligible families.

For more information visit rapc.org/ncprek or contact Barbara Jefferys at bjefferys@rapc.org or 586-0661.

CHILD CARE SUBSIDY

When state funding is not available for eligible families, we provide Smart Start childcare subsidy to help families with the cost of childcare. We help improve the quality of infant and toddler childcare by paying subsidy enhancements to childcare facilities that provide high quality care.

For more information, please visit swcdcinc.org/subsidy-program or call Cindy Moody at 828-477-4530.

EARLY LITERACY COORDINATION

Providing early literacy enrichment for children ages prenatal through age five by engaging parents and caregivers, pediatricians, library systems and community partners in a variety of coordinated and networked activities and events that promote early access to pre-reading materials, and school readiness.

For more information, contact Deanna Lyles at dlyles@rapc.org or 586-0661.



SMART START/LICC

The SS/LICC (Smart Start/Local Interagency Coordinating Council) is composed of community members and parents with an interest in enriching and coordinating quality services for children and families, including children with special needs.

Everyone who attends meetings does so on a volunteer basis.

Everyone brings a valuable point of view to the group. Meetings are open to the public.

For more information about SS/LICC, please contact Jody Miller at 586-0661 or jmiller@rapc.org.

WAGES

We provide childcare professionals enrolled in early childhood degree programs with salary supplements tied to their level of education to reduce turnover and increase education of teachers in childcare.

If you are interested in learning more about this program, please visit rapc.org/wages or childcareservices.org/programs/wages

FAMILY SUPPORT NETWORK OF REGION A

We want families to know they are not alone in caring for a child with special needs.

We help build community support for families, providing information and resources for parents and caregivers of children with special needs.

For more information, contact Jody Miller at 586-0661 or jmiller@rapc.org.

TRAINING FOR CHILDCARE PROFESSIONALS

We offer childcare professionals training, support and important resources to assist them in providing high quality care for all children.

Special trauma informed training for professionals helps them build resilience with children and cope effectively with challenging behaviors in the classroom.

For more information on training opportunities, visit rapc.org/professional.

REGION A PARTNERSHIP FOR CHILDREN

116 Jackson Street, Sylva, NC 28779 / 828-586-0661 / rapc.org /  [@rapc.org](https://www.facebook.com/rapc.org)

Janice M. Edgerton, Executive Director / jedgerton@rapc.org